

IDF750

T E C H N I C A L M A N U A L

Injector Dynamics 



T A B L E O F C O N T E N T S

Page 2..... Precautions, Purpose

Page 3..... Filtration Specification

Page 4-6.....DeltaP Indicator

Page 7..... Modular Bracket, Schrader Relief/Drain Valve, Safety Latch

Page 8..... Servicing

Page 9..... Optional PTS Block, Specifications and Limitations

Page 10-12..... Bosch Motorsport Sensor Specification

Be Careful!

Please pay attention, and use common sense when installing the product. We have made every effort to warn you of potentially dangerous practices, but the best protection is for you to take your time, pay attention, and do the job correctly. Getting hurt is not worth any time you may save by ignoring dangerous installation practices.

Note: We strongly recommend having at least one fire extinguisher on hand any time the fuel system is worked on. They are available at all hardware stores, Walmart, Amazon, and even most grocery stores for as little as \$20. Twenty dollars that could save your car, your building, or even your life!

Be smart, and be safe.

Purpose

Electronic fuel injectors are built to precise dimensions, measured in microns. The smallest particles can result in rapid wear, or even destroy a fuel injector.

Bosch provides a specification for protection of electronic fuel injectors, which is a minimum capture efficiency of 87% at 5 microns, and 100% capture efficiency at 35 microns. This means that the filter will capture at least 87% of all particles 5 microns and larger, and 100% of all particles 35 micron and larger.

The ID F750 is designed to offer compatibility with all fuels while meeting this specification, without undue flow restriction.

The chart below shows capture efficiency vs particle size for the ID F750 element.

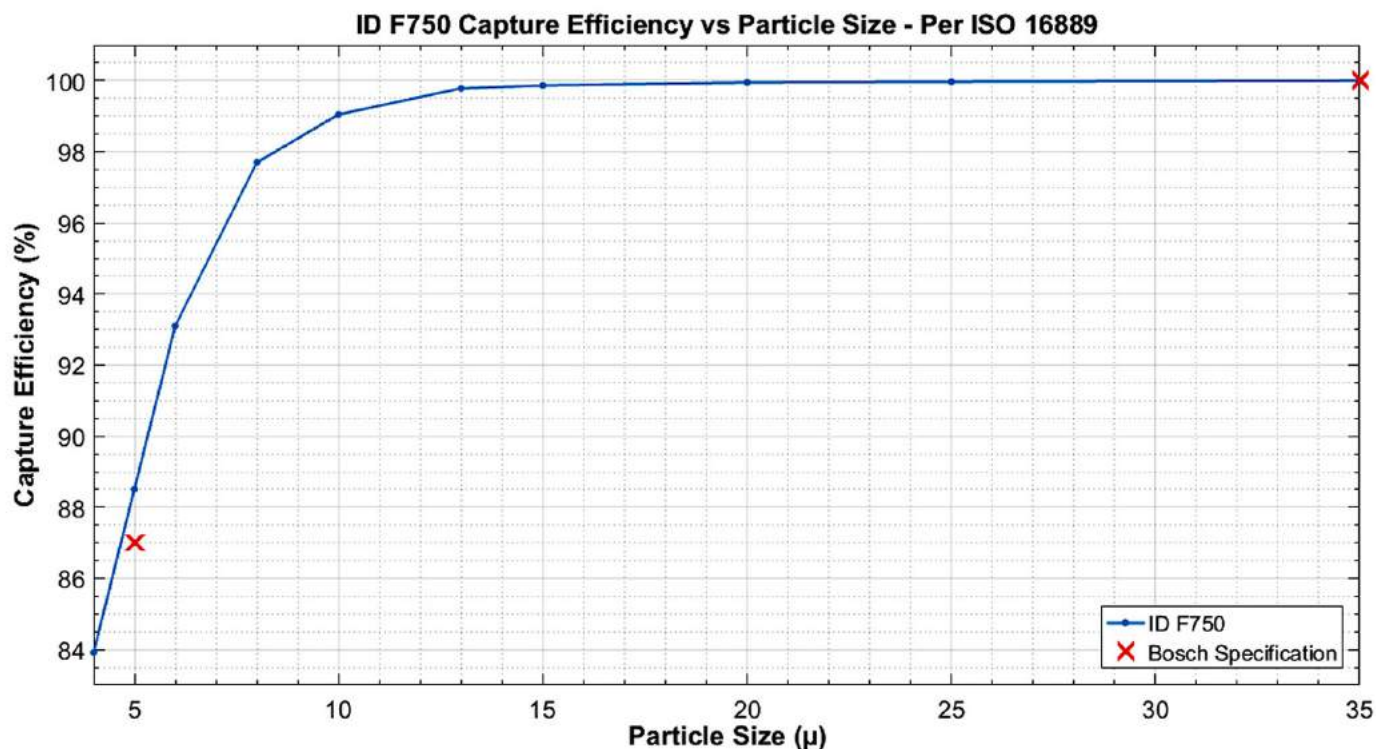

Note that for a filter specification to be meaningful, particle diameter and capture efficiency must both be stated. A nominal filter rating is useless, as it says nothing about the efficiency at the stated particle size.

To illustrate this point, the chart below shows the advertised nominal micron rating of numerous commonly available fuel filters, and their measured capture efficiency using the ISO 16889 test method, with particles sizes ranging from 4-25 micron.

An absolute rating specifies the largest diameter particle that will pass through the filter. It is approximately equal to the 100% efficiency point on the graph above.

Example - The 3 micron filter shown in pink has an absolute rating of approximately 15 microns.

This rating offers some relevance, as it indicates the absolute limit, but it says nothing about the filter efficiency for particles smaller than the stated diameter, and so its usefulness is somewhat limited.

It is this ambiguity in filter specification, and the realization that proper filtration specifications were not being met that ultimately lead to the design of the ID F750.

In addition to offering appropriate filtering, the ID F750 includes numerous features not seen before in the performance aftermarket.

These features are designed to make the filter easier to use and service, and are detailed below.

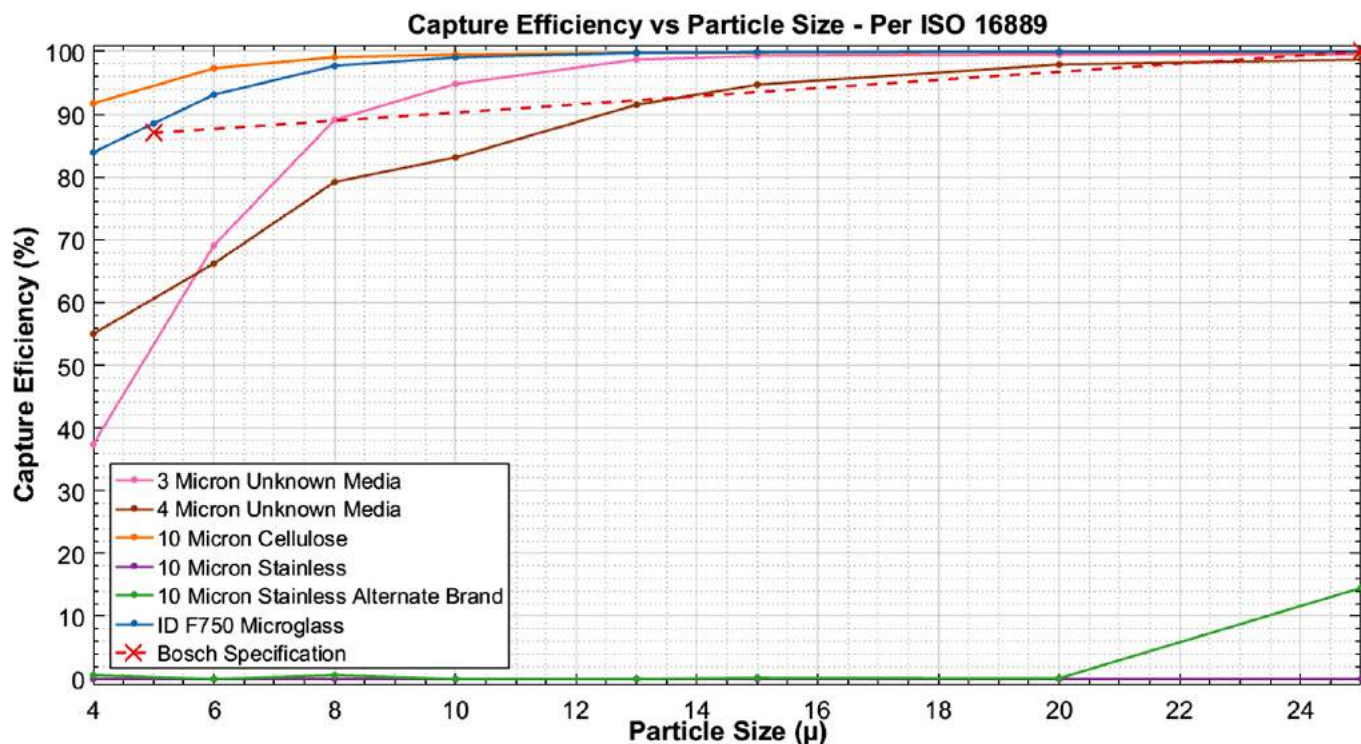

DeltaP Indicator

The built in DeltaP indicator displays the pressure difference between the filter inlet and outlet, which indicates the condition of the filter element.

During zero flow, zero DeltaP, the edge of the white indicator band is roughly lined up with the first tick mark on the scale. The second tick mark represents a DeltaP of approximately 0.25 bar.

Once the indicator enters the hash marked section of the scale, DeltaP is approximately 0.35 bar, and should be monitored closely, and replaced before reaching the solid white section of the scale which represents in excess of 0.50 bar DeltaP.

The chart below shows DeltaP, (Pressure loss) vs. flow and contaminant level.



DeltaP is displayed real time, and should be measured during highest flow conditions.

Before describing the operation and use of the indicator in further detail, it is best to define units of pressure measurement, and system flow during various operating conditions.

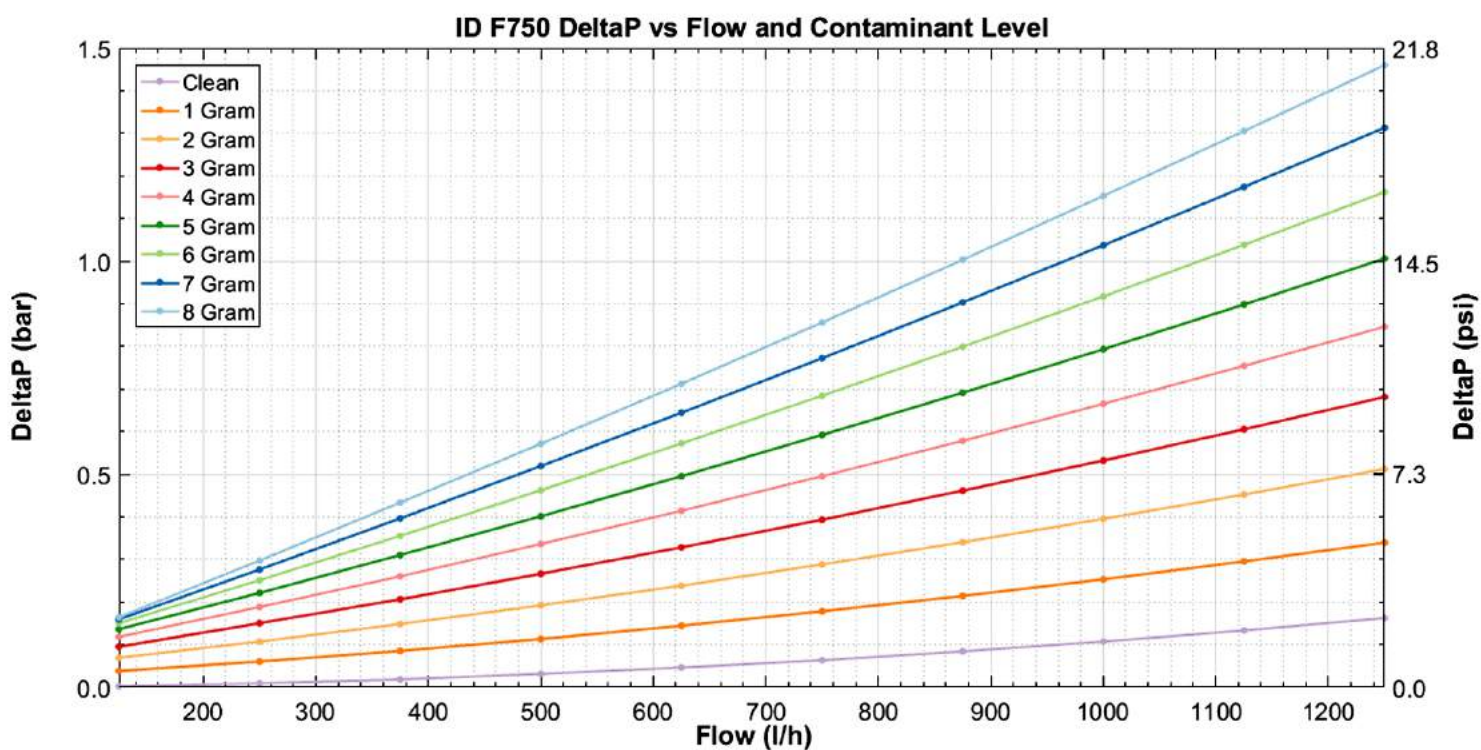

Pressure

There are three standard methods of stating pressure.

Absolute Pressure

Pressure relative to the vacuum of space.

Gauge Pressure

Pressure relative to atmospheric pressure, which is approximately one bar at sea level.

Differential Pressure

Difference in pressure between any two points. Often referred to as DeltaP.

Note that the pressure at any point in the system can be defined by any of these three pressure units, but when performing mathematical calculations, it is best to work in units of absolute pressure, converting to units of choice once the calculations are complete.

For example, let us consider a MAP referenced return style fuel system, with a differential pressure of 3.0 bar, noting pressure at several points in the system under various operating conditions.

Atmospheric Pressure

In our example, atmospheric pressure is 1 bar absolute.

Manifold Pressure

Note that the A in MAP stands for absolute, and so MAP is always stated in units of absolute pressure. At idle, MAP will vary based on engine speed, accessory load, camshaft position, compression ratio, etc, but for the sake of our example, it is 30 kPa, or 0.3 bar. If our example engine is naturally aspirated, MAP will be at or near atmospheric pressure at wide open throttle (WOT) which we have already stated is 1 bar. If our example engine is boosted, and capable of 1 bar of boost, MAP at full boost will be 2 bar.

Fuel Pressure

Because the example system is MAP referenced, fuel pressure will change as MAP changes, to maintain a constant differential pressure across the fuel injectors.

Idle – MAP = 0.3 bar

To maintain a differential pressure of 3.0 bar across the fuel injector, the absolute fuel pressure must be 3.0 bar higher than MAP, for an absolute pressure of 3.3 bar. As measured on a fuel pressure gauge, the pressure would 3.3 bar absolute, minus 1.0 bar atmospheric, for a gauge pressure of 2.3 bar. The fuel pump, having outlet pressure equal to fuel pressure, and having inlet pressure equal to atmosphere, will have a differential pressure of 2.3 bar.

Naturally Aspirated WOT – MAP = 1.0 bar

To maintain a differential pressure of 3.0 bar across the fuel injector, the absolute fuel pressure must be 3.0 bar higher than MAP, for an absolute pressure of 4.0 bar. As measured on a fuel pressure gauge, the pressure would 4.0 bar absolute, minus 1.0 bar atmospheric, for a gauge pressure of 3.0 bar. The fuel pump, having outlet pressure equal to fuel pressure, and having inlet pressure equal to atmosphere, will have a differential pressure of 3.0 bar.

Boosted – 1.0 bar - MAP = 2.0 bar

To maintain a differential pressure of 3.0 bar across the fuel injector, the fuel absolute pressure must be 3.0 bar higher than MAP, for an absolute pressure of 5.0 bar. As measured on a fuel pressure gauge, the pressure would 5.0 bar absolute, minus 1.0 bar atmospheric, for a gauge pressure of 4.0 bar. The fuel pump, having outlet pressure equal to fuel pressure, and having inlet pressure equal to atmosphere, will have a differential pressure of 4.0 bar.

	Manifold Pressure Absolute	Fuel Injector Differential	Fuel Pressure Absolute	Fuel Pressure Gauge	Fuel Pump Differential
Idle	0.3	3.0	3.3	2.3	2.3
NA Wide Open Throttle	1.0	3.0	4.0	3.0	3.0
Boosted - 1.0 Bar Boost	2.0	3.0	5.0	4.0	4.0

Now consider that with the exception of the Injector Dynamics speed controlled brushless pump, flow will increase as differential pressure across the pump decreases.

The chart below shows flow vs pressure of paired Walbro 267's as an example.

Using the information below, we can see that the total pump flow will be 785 l/h at idle, 710 l/h naturally aspirated at WOT, and 655 l/h operating at 1.0 bar boost.

From this, we can see that maximum system flow will occur at idle, and it is under these conditions that DeltaP should be monitored.

To check the condition of the filter element, simply note the DeltaP at idle, knowing that it represents worst case conditions.

Also note that the total flow in a return-less system is quite different, and maximum flow will occur at or near the horsepower peak.

While DeltaP could be monitored at peak horsepower on the dyno, or even by video while on track, the indicator should only be considered practically useful on a return style system.

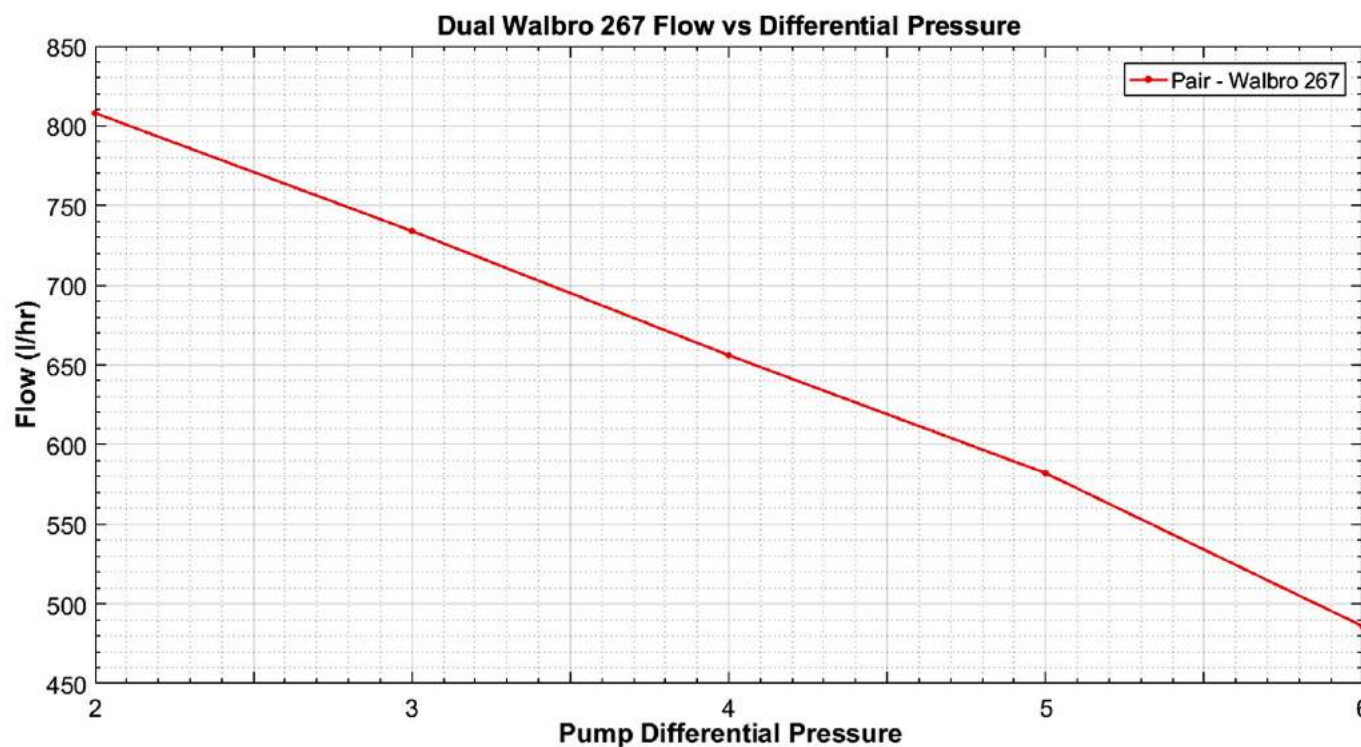



◀ Modular Bracket

The dovetail jointed bracket is designed to accommodate numerous fitments, from the standard 90 degree bracket, to custom application specific brackets. CAD models of the dovetail joint are available for those who wish to design and build their own custom brackets.

It is also designed to allow for easy removal of the filter assembly, by loosening the locking screws, and sliding the filter free of the dovetail joint.

The supplied fasteners are M4 x 0.7. The bracket will also accept SAE 10-32 or 10-24.

Note that the filter full of fuel is relatively heavy. Make sure the mounting surface is sufficiently rigid, and use a backup plate if necessary.

Schrader Test/Drain Port ▶

The Schrader valve exists to simplify de-pressurizing the system, allow for easy monitoring of fuel pressure using standard automotive diagnostic tools, and to simplify fuel sampling for compliance testing.

Note: The hose barb adapter is intended for draining the system and relieving pressure only. It is not intended to be used under pressure. Do not attach a pressure gauge, or any other type of restriction to the end of the hose.

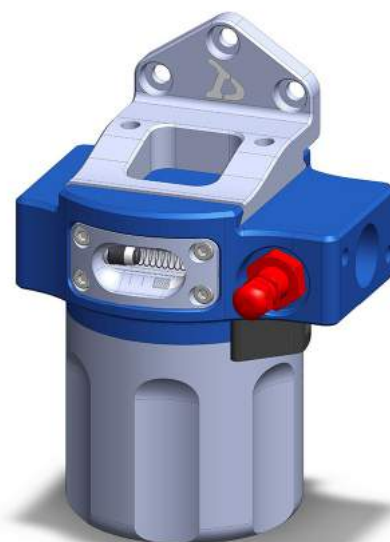

◀ Spin on Housing with Safety Latch

The safety latch is intended as a safety measure, to keep the filter cup from spinning loose in case it is installed incorrectly. It is not intended to be the main source of securement.

The filter cup is secured by hand tightening, just as you would a standard oil filter, the difference being that no o-ring compression is required, and the threads offer a positive stop when fully tightened.

The latch is spring loaded, and can be released with a single finger, leaving the other hand free to remove the filter cup.

Servicing

Relieving Pressure

The ID F750 has been designed to make element changes quick and simple.

The first step is to release pressure from the system, which is done with the Schrader adapter.

The Schrader adapter has an internal o-ring which seals against the o.d. of the valve.

As the adapter is threaded on, the o-ring will contact the body first, offering a fuel tight seal, and then the diffuser will contact the pintle, opening the Schrader valve.

To relieve the system pressure, simply remove the cap from the Schrader valve, attach a piece of hose the Schrader adapter to direct fuel flow into a safe container, thread the adapter onto the valve, and let the system pressure bleed off, which should take no more than a few seconds.

Be careful not to cross thread the Schrader Adapter as the threads are made of plastic, and can be damaged quite easily.

Under no circumstances should the Schrader Adapter and attached hose be pressurized. Fuel must be allowed to flow freely. Do not add a pressure gauge, or any type of restriction to the hose. Doing so will cause an immediate failure and fuel leakage.

Once the system pressure is relieved, the Schrader Valve must be re-sealed with the supplied metal cap, as it is the cap, not the pintle valve that provides the main seal. Do not seal the valve with any alternative cap, as the supplied cap is provided specifically for sealing automotive fuels at high pressure.

Replacing the Element

Once pressure is relieved, the filter cup can be removed by releasing the safety latch, and spinning the cup free. The filter element is removed by pulling straight down.

Replace the old element and o-ring with new pieces, being sure to lubricate each with engine oil, grease, etc.



Monitoring Fuel Pressure

The Schrader valve uses a standard 305-32 thread and should be compatible with common automotive diagnostic equipment.

Optional PTS Block ▶

The add on PTS block (Sold separately) is designed to simplify the addition of fuel pressure and temperature sensors.

Adding just 27mm to the overall width of the assembly, in many cases it can be installed without the need to make new hoses.

It installs with two screws, and re-uses your original hose end fitting.

With the exception of wiring, it can be installed in a matter of minutes.

It features a high quality Bosch Motorsport 0-10 bar gauge fuel pressure sensor, and a -40C to 140C fuel temperature sensor.

Complete sensor specifications can be found on pages 10-12.

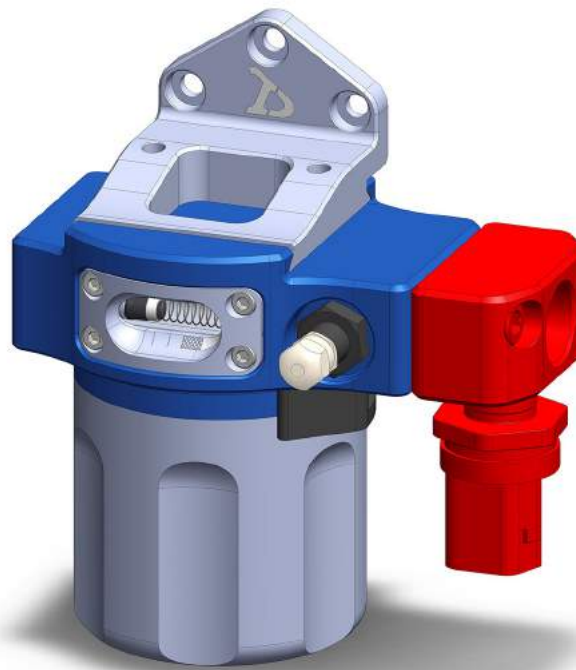

Specifications/Limitations

- O-rings: Fluorosilicone
- Body: Aluminum 6061-T651, Type II Anodized
- Fasteners: 18-8 Stainless Steel
- Filter Media: Microglass
- Media Compatibility: All known automotive fuels.

- Maximum Operating Temperature: 110 °C
- Maximum Operating Pressure: 10 bar
- Maximum Differential Pressure: 1 bar
- Maximum Flowrate: See DeltaP vs Flow and Contaminant Level Chart, page 4
- Burst Pressure: 35 bar

- Inlet/Outlet Configuration: -8 SAE J1926 Port (9/16-18 ORB)
- PTS Block Fasteners: Socket head screw, M6x1.0x25
- Bracket Fasteners – Bracket to Body : Cup point set screw, M6x1.0x10
- Bracket Fasteners – Bracket to Vehicle: Supplied M4x0.7x25

Note: The ID F750 is not intended for use on the high pressure side of a DI fuel system. It will fail immediately, and catastrophically.

Pressure Sensor Combined PST-F 1

www.bosch-motorsport.com



- ▶ Relative fluid pressure and temperature measurements
- ▶ Pressure measurement range 0 to 10 bar
- ▶ Temperature measurement range -40 to 140°C

This sensor is designed to measure relative gasoline pressure and gasoline temperature in port injection systems.

The pressure measurement of the sensor is by means of a piezoresistive element which is acted on by a silicon diaphragm in contact with the fluid being measured. The reference (relative) pressure is provided via an opening in the sensor housing and acts on the active upper side of the silicon diaphragm.

Application

Application 1	0 to 10 bar (a)
Application 2	-40 to 140°C
Reference	Relative
Max. pressure	20 bar
Operating temp. range	-40 to 140°C (140°C)
Media temp. range	-40 to 140°C (140°C)
Storage temp. range	-30 to 80°C
Fuel compatibility	Engine oils, most gasoline and Diesel fuels
Max. vibration	80 m/s ² at 20 to 260 Hz 60 m/s ² at 260 to 520 Hz

Technical Specifications

Mechanical Data

Male thread	M10x1
Weight without wire	36 g
Wrench size	27 mm
Installation torque	40 Nm
Sealing	Sealed cone

Electrical Data

Power supply U_s	4.75 to 5.25 V
Max power supply U_s max	16 V
Full scale output U_A	0.5 to 4.5 V U_s ratiometric
Current I_s	10 mA

Characteristic 1

Response time T10/90	Pressure: <5 ms Temperature: 9 s (response time of temperature signal in oil dip bath 20 to 100°C)
Compensated range	-40 to 130°C
Tolerance (FS) at U_s	+/-2 % at 25 to 85°C

Sensitivity 400 mV/bar at $U_S = 5\text{ V}$

Offset 500 mV at $U_S = 5\text{ V}$

Characteristic 2

T [°C] R [Ohm]

-40 44,864

-30 25,524

-20 15,067

-10 9,195

0 5,784

10 3,740

20 2,480

30 1,683

40 1,167

50 824

60 594

70 434.9

80 323.4

90 244

100 186.6

110 144.5

120 113.3

130 89.9

140 71.9

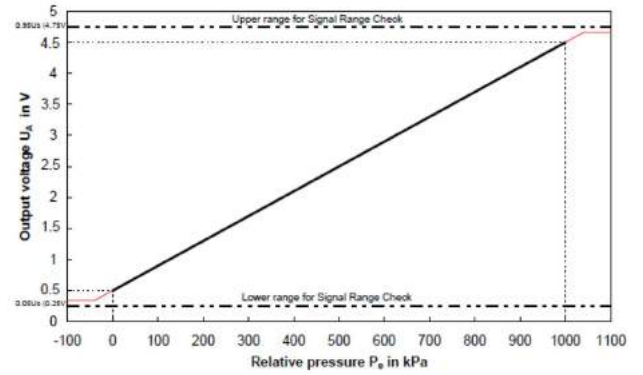
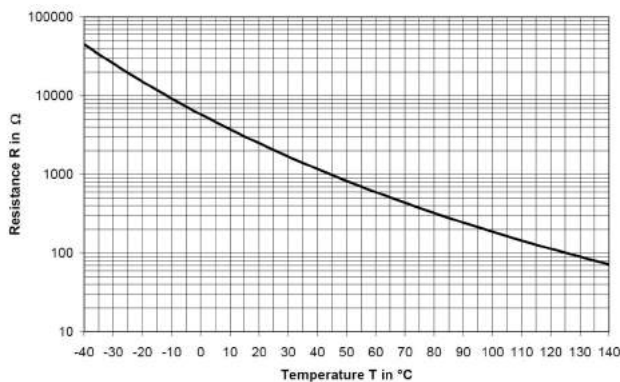

Connectors and Wires

Connector	Bosch Trapezoid
Mating connector	F 02U B00 751-01
Pin 2	Sig
Pin 3	U_S
Pin 4	Gnd
Pin 5	NTC

Installation Notes

The sensor can be connected directly to most control units.

For temperature measurement please use a pull-up resistor with an optimal value of 4.6 kOhm.

Please note that using the adapter F 02U 002 956-01 in connection with the PST-F 1 the ambient conditions could be changed (e.g. medium temperature dissipation or undesired vibrations).

The sensor has a protection for overvoltage, reverse polarity and short-circuit.

Please find further application hints in the offer drawing and free download of the sensor configuration file (*.sdf) for the Bosch Data Logging System at our homepage.

Safety Note

The sensor is not intended to be used for safety related applications without appropriate measures for signal validation in the application system.

Ordering Information

Pressure Sensor Combined PST-F 1
Order number **F 02U V0U 194-01**

Dimensions

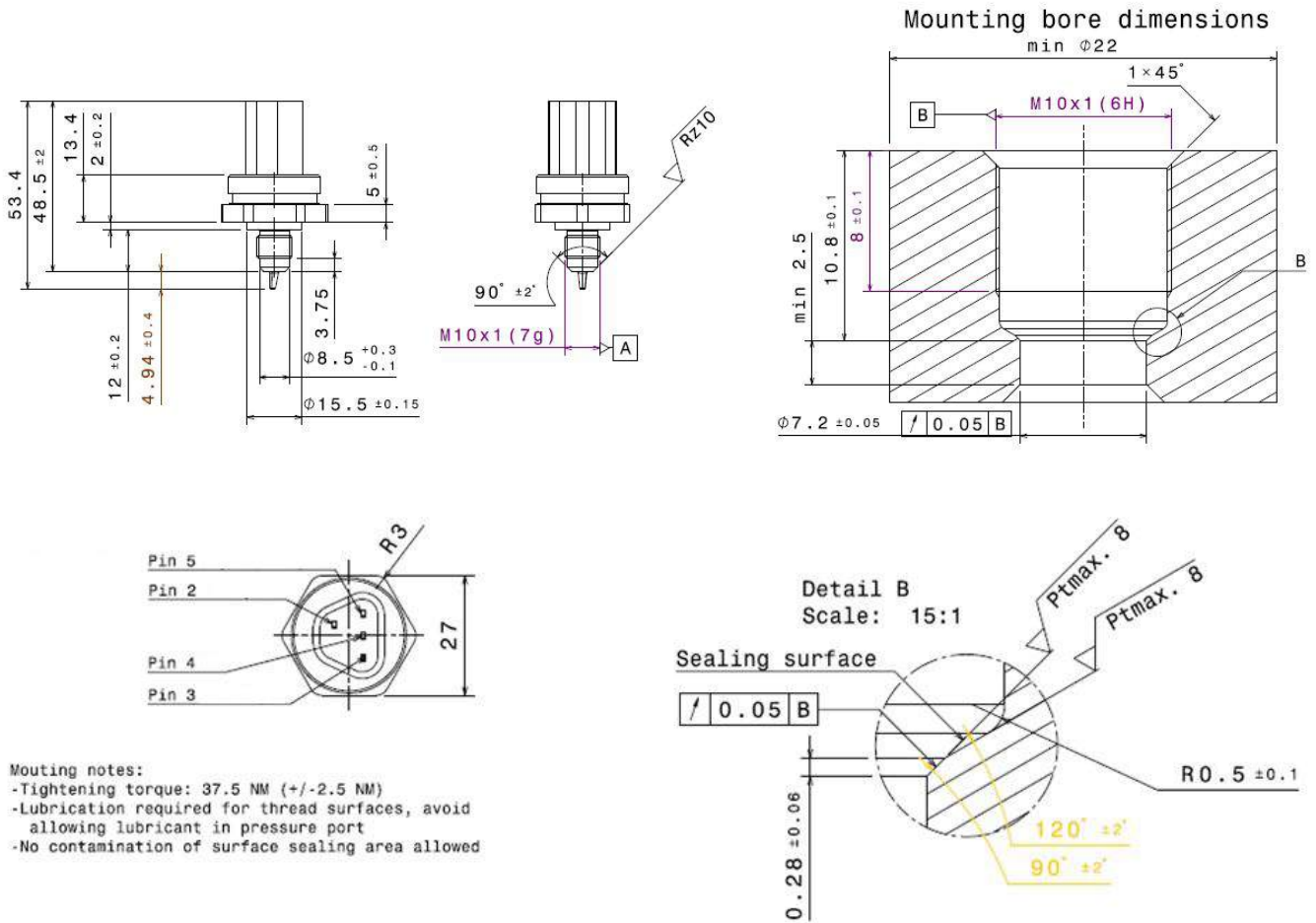

Mounting notes:

- Tightening torque: 37.5 NM (+/-2.5 NM)
- Lubrication required for thread surfaces, avoid allowing lubricant in pressure port
- No contamination of surface sealing area allowed

Represented by:

Europe:
 Bosch Engineering GmbH
 Motorsport
 Robert-Bosch-Allee 1
 74232 Abstatt
 Germany
 Tel.: +49 7062 911 9101
 Fax: +49 7062 911 79104
 motorsport@bosch.com
 www.bosch-motorsport.de

North America:
 Bosch Engineering North America
 Motorsport
 38000 Hills Tech Drive
 Farmington Hills, MI 48331-3417
 United States of America
 Tel.: +1 248 876 2977
 Fax: +1 248 876 7373
 motorsport@bosch.com
 www.bosch-motorsport.com

Latin America:
 Robert Bosch Ltda
 Motorsport
 Av Juscelino Kubitscheck de
 Oliveira 11800
 Zip code 81460-900
 Curitiba - Parana
 Brasilia
 Tel.: +55 41 3341 2057
 Fax: +55 41 3341 2779

Asia-Pacific:
 Bosch Engineering Japan K.K.
 Motorsport
 18F Queen's Tower C, 2-3-5 Minato Mirai
 Nishi-ku, Yokohama-shi
 Kanagawa 220-6218
 Japan
 Tel.: +81 45 650 5610
 Fax: +81 45 650 5611
 www.bosch-motorsport.jp

Australia, New Zealand and South Africa:
 Robert Bosch Pty. Ltd
 Motorsport
 1555 Centre Road
 Clayton, Victoria, 3168
 Australia
 Tel.: +61 (3) 9541 3901
 motor.sport@au.bosch.com